



**Dedacciai** 25 ALUMINUM  
1992 - 2017





## Dedacciai aluminum tubing constitute a large family of high performance products.



Dedacciai designs and manufactures light aluminum alloy tubing more than 20 years ago, and this catalogue is the result of our passion and millions of kilometers rides all over the world roads by our testers, professional teams athletes, cyclists and friends.

Dedacciai light alloy tubing are available in two classes:

- **AEGIS** class tubing: state of the art light tubing, designed for racing and high performances frames. They are made of Scandium, 7005 and EN-AW 7020 alloy

- **FIRE** class tubing: designed and engineered for the maximum reliability and easy frame assembling. They are made of 7005 alloy.

All our aluminum tubing are seamless, manufactured and heat treated with water quench technology in our plant in Campagnola Cremasca, Italy.

In order to obtain the best results from the use of this class of products, please look carefully at the drawings, and read our advices at the end of this catalogue.



# Aegis top tubing

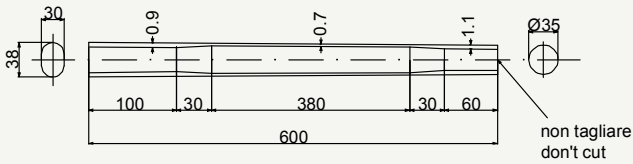

cod : MTO350Y101

Alloy	Weight	Use
SC	139 g	Road Light

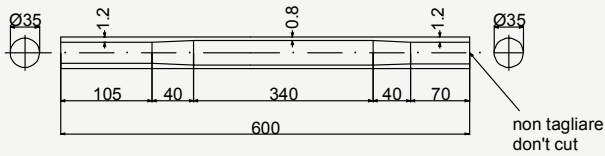

cod : MTO350U102

Alloy	Weight	Use
SC	168 g	Road - Cyclocross - MTB

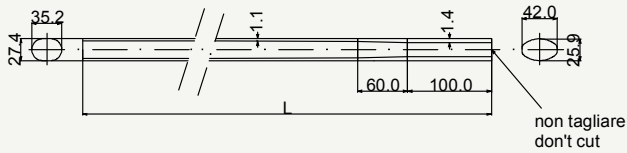

cod : MTO350E10117

Alloy	Lenght	Weight	Use
7005	540	180 g	Road - Track

cod : MTO350E10118

Alloy	Lenght	Weight	Use
7005	600	201 g	Road - Track

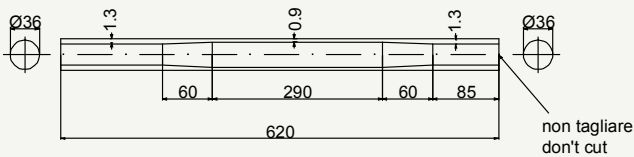

cod : MTO360E301

Alloy	Weight	Use
7005	208 g	Road - Cyclocross - MTB

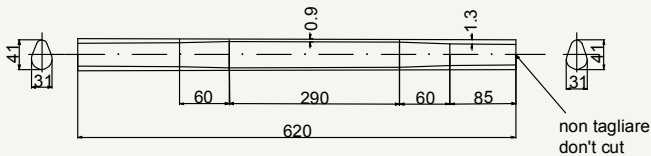

cod : MTO360E30140

State	Weight	Use
7005	208 g	Road - Cyclocross - MTB

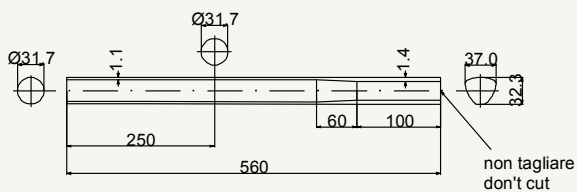

cod : MTO350E10119

Alloy	Weight	Use
7005	191 g	Road

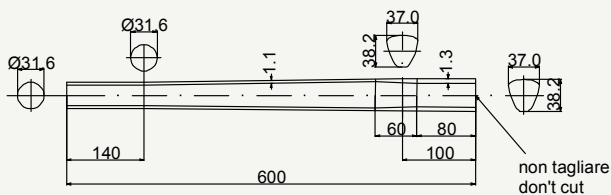

cod : MTO380E20119

State	Weight	Use
7005	218 g	Road

# Aegis top tubing

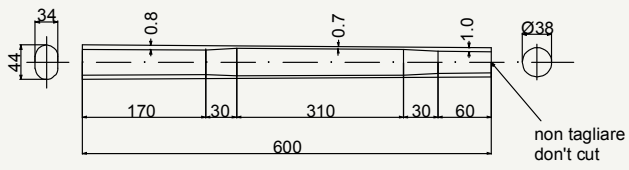

cod : MTO380U101

Alloy	Weight	Use
SC	154 g	Road

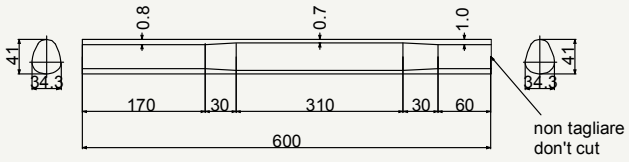

cod : MTO380U103

State	Weight	Use
SC	154 g	Road

# Aegis down tubing

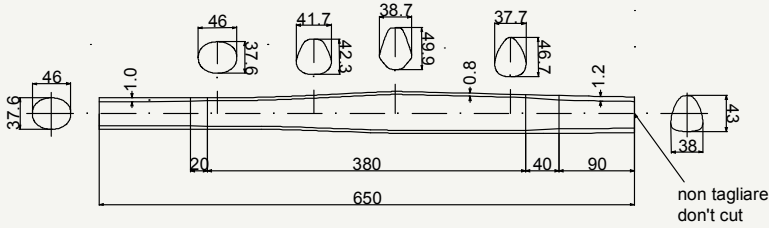

cod : MTQ400Y101

Alloy	Weight	Use
SC	182 g	Road

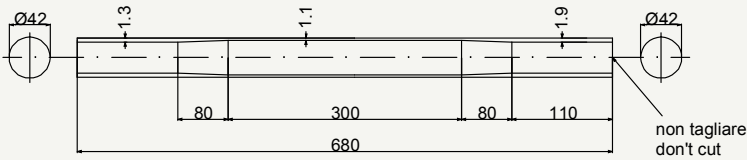

cod : MTQ420E501

Alloy	Weight	Use
7005	329 g	Road - Cyclocross - MTB

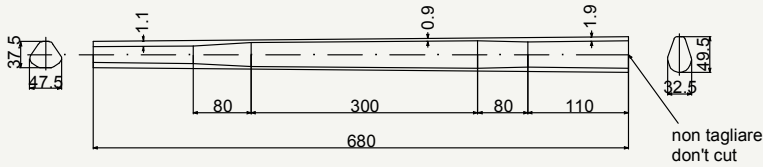

cod : MTQ420E50315

Alloy	Weight	Use
7005	329 g	Road - Cyclocross - MTB

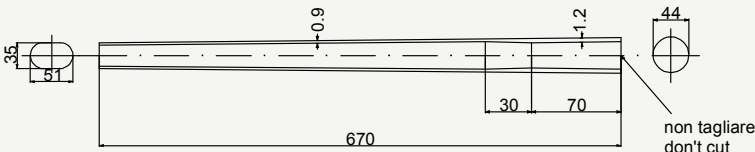

cod : MTQ440U602

Alloy	Weight	Use
SC	205 g	Road

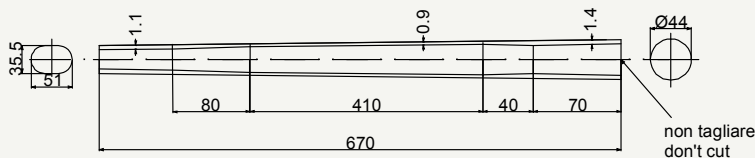

cod : MTQ440U601

Alloy	Weight	Use
SC	259 g	Road - Cyclocross

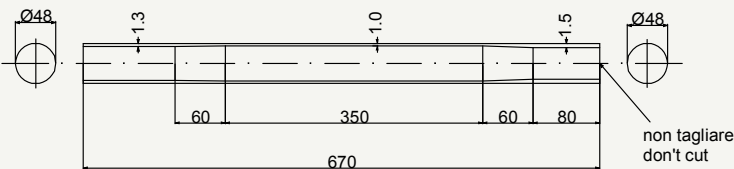

cod : MTQ480E101

Alloy	Weight	Use
7005	320 g	Road

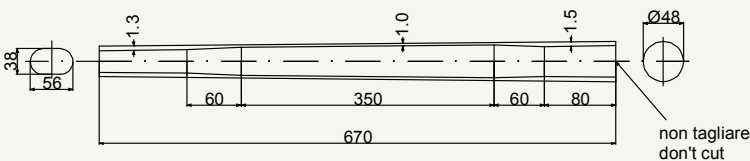

cod : MTQ480E10113

Alloy	Weight	Use
7005	320 g	Road



# Aegis down tubing

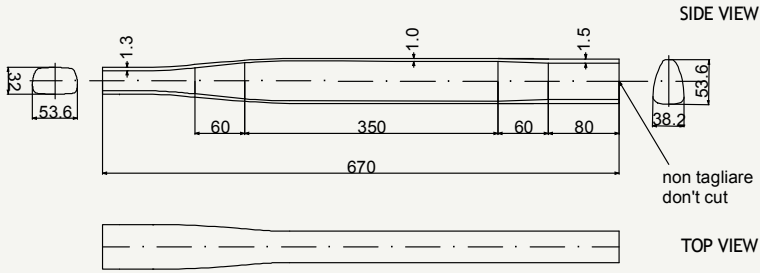

cod : MTQ480E10114

Alloy	Weight	Use
7005	320 g	Road

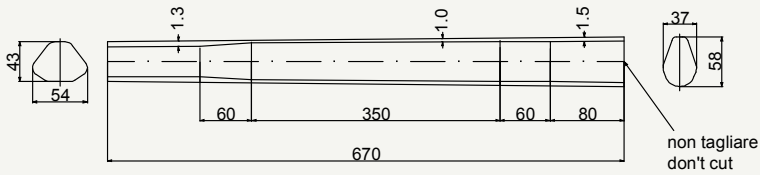

cod : MTQ480E10111

Alloy	Weight	Use
7005	320 g	Road - Track

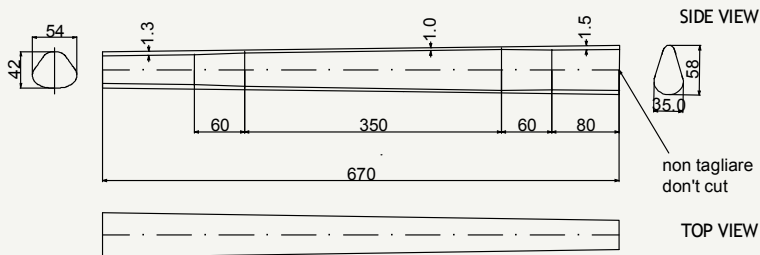

cod : MTQ480E10112

Alloy	Weight	Use
7005	320 g	Road - Track

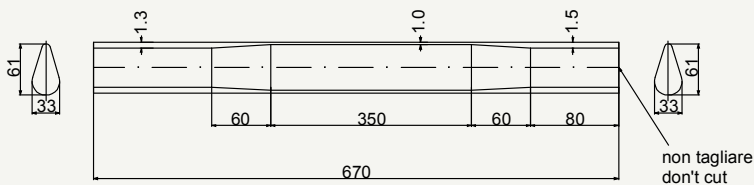

cod : MTQ480E10146

Alloy	Weight	Use
7005	320 g	Crono

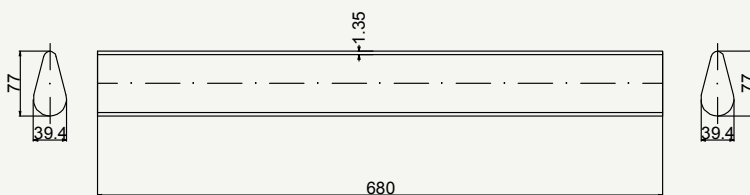

cod : MTQ600E801

Alloy	Weight	Use
7005	466 g	Crono

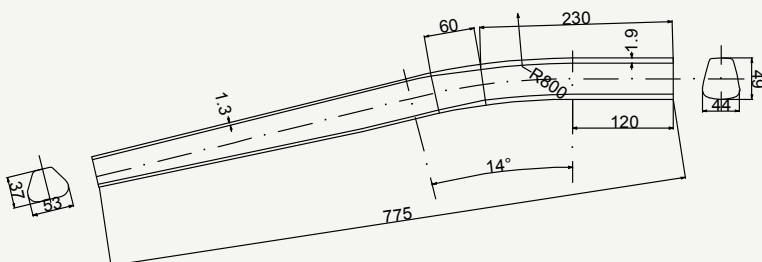

cod : MTQ480E1021

Alloy	Weight	Use
7005	488 g	MTB 29"

# Aegis seat tubing

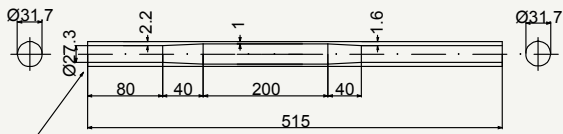

non tagliare  
don't cut

cod : MTV317E104

Alloy	Weight	Use
7005	201 g	Road - Cyclocross - MTB

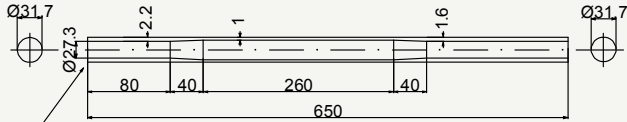

non tagliare  
don't cut

cod : MTV317E102

Alloy	Weight	Use
7005	242 g	Road - Cyclocross

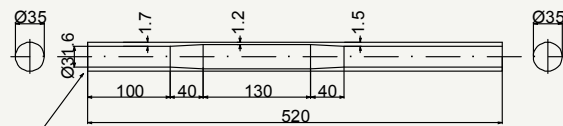

non tagliare  
don't cut

cod : MTV350E309

Alloy	Weight	Use
7005	218 g	Road - Cyclocross - MTB

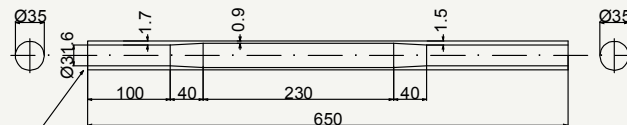

non tagliare  
don't cut

cod : MTV350E308

Alloy	Weight	Use
7005	248 g	Road - Cyclocross

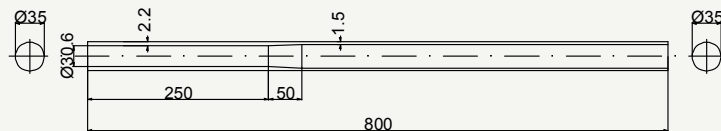

cod : MTV350E312

Alloy	Weight	Use
7005	407 g	Road



# Aegis chain stay

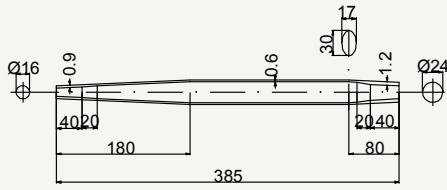

SIDE VIEW

cod : MPO240U101

Alloy	Weight	Use
SC	72 g	Road Light

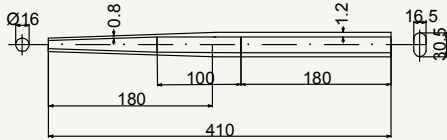

SIDE VIEW

cod : MPO254U1012

Alloy	Weight	Use
SC	89 g	Road

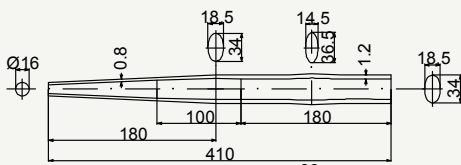

SIDE VIEW

cod : MPO254U1013

Alloy	Weight	Use
SC	89 g	Road - Track

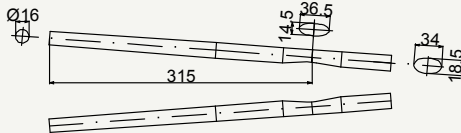

TOP VIEW

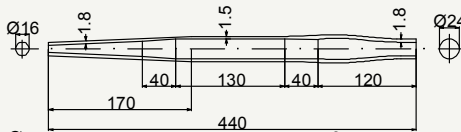

SIDE VIEW

cod : MPO240E1016

Alloy	Weight	Use
7005	141 g	Cyclocross Disc Brake

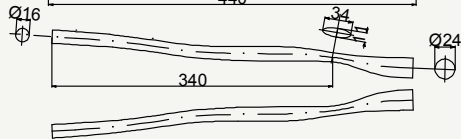

TOP VIEW

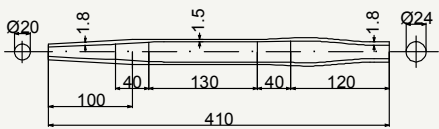

SIDE VIEW

cod : MPO240E1017

Alloy	Weight	Use
7005	141 g	Cyclocross Disc Brake

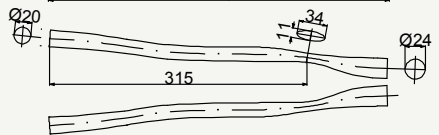

TOP VIEW

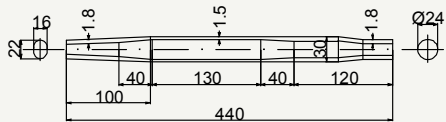

SIDE VIEW

cod : MPO240E10131

Alloy	Weight	Use
7005	141 g	Gravel - MTB 29"

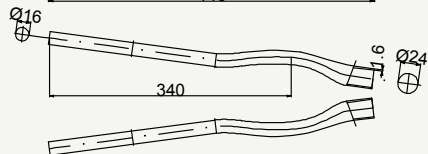

TOP VIEW

# Aegis chain stay

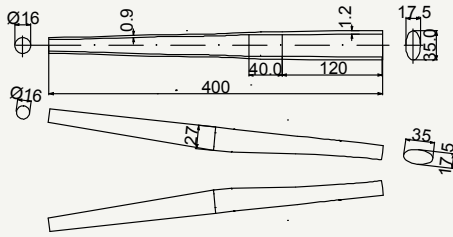

SIDE VIEW

TOP VIEW

cod : MPO272U204

Alloy	Weight	Use
SC	83 g	Road

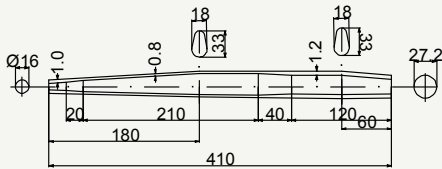

SIDE VIEW

cod : MPO272U201

Alloy	Weight	Use
SC	83 g	Road

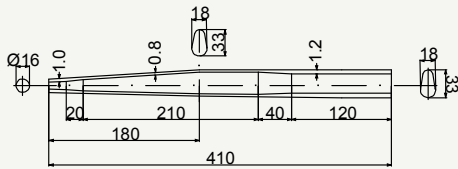

SIDE VIEW

cod : MPO280E101

Alloy	Weight	Use
SC	83 g	Road - Crono

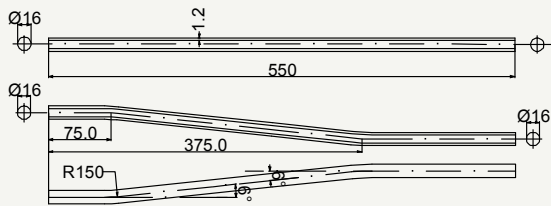

SIDE VIEW

cod : MPV160E10110

Alloy	Weight	Use
7005	87 g	Road Light

TOP VIEW

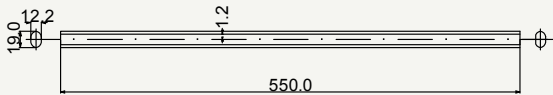

SIDE VIEW

cod : MPV160E1011

Alloy	Weight	Use
7005	87 g	Road Aero

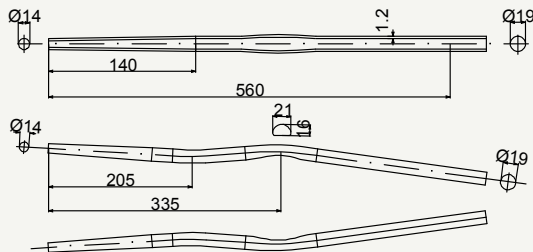

SIDE VIEW

cod : MPV190E10135

Alloy	Weight	Use
7005	96 g	Cyclocross

TOP VIEW

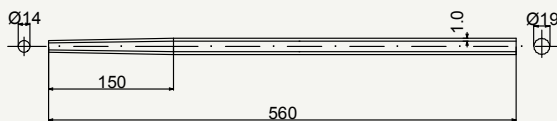

cod : MPV190E102

Alloy	Weight	Use
7005	87 g	Road



SIDE VIEW

cod : MPV190E1021

Alloy	Weight	Use
7005	87 g	Road Aero

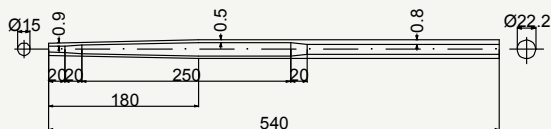

cod : MPV220Y102

Alloy	Weight	Use
SC	67 g	Road Light

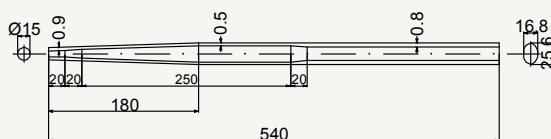

SIDE VIEW

cod : MPV220Y1023

Alloy	Weight	Use
SC	67g	Road Aero

# Fire top tubing

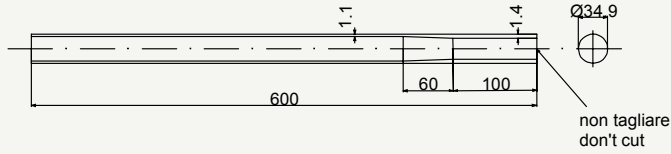

cod : MTO350E10111

Alloy	Weight	Use
7005	215 g	Road - Cyclocross

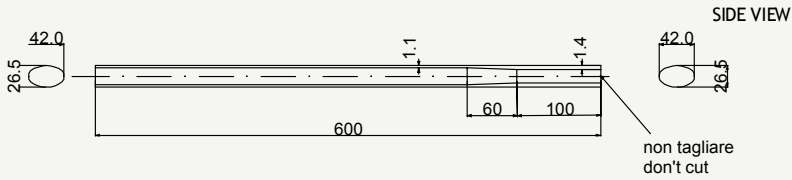

cod : MTO350E10114

Alloy	Weight	Use
7005	215 g	Road - Cyclocross

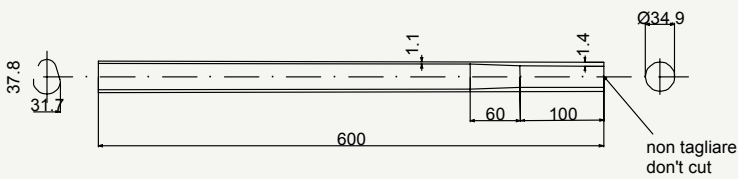

cod : MTO350E10110

Alloy	Weight	Use
7005	215 g	Road

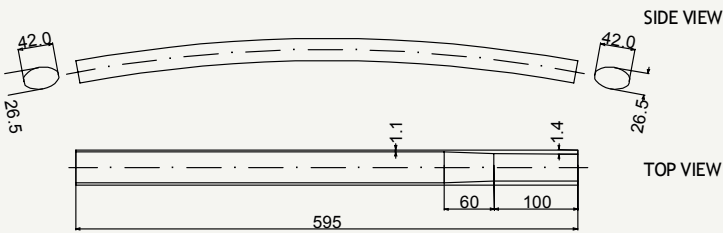

cod : MTO350E10112

Alloy	Weight	Use
7005R	215 g	oad

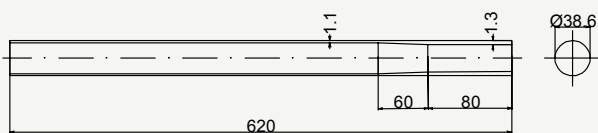

cod : MTO380E201

Alloy	Weight	Use
7005	230 g	Road

# Fire down tubing

7005 HEAT TREATED ALLOY

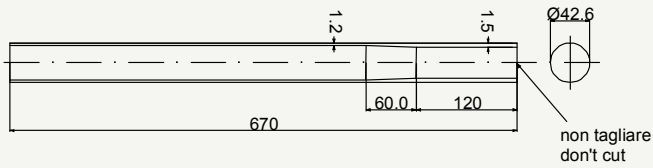

cod : MTQ426E50111

Alloy	Weight	Use
7005	332 g	Road

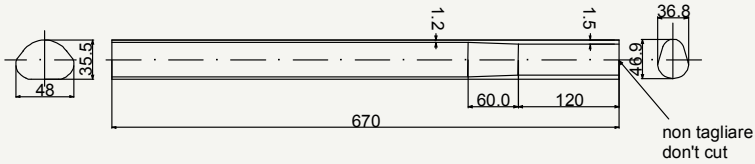

cod : MTQ426E50110

Alloy	Weight	Use
7005	332 g	Road

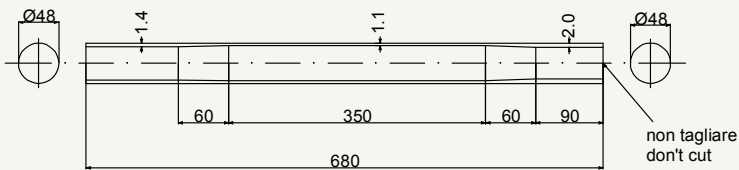

cod : MTQ480E103

Alloy	Weight	Use
7005	365 g	Road - Cyclocross - MTB

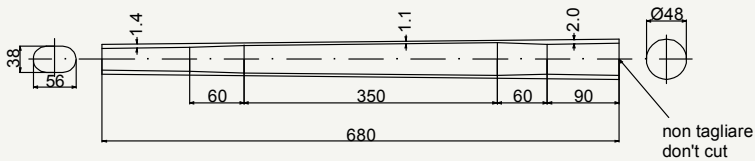

cod : MTQ480E10312

Alloy	Weight	Use
7005	365 g	Road - Cyclocross - MTB

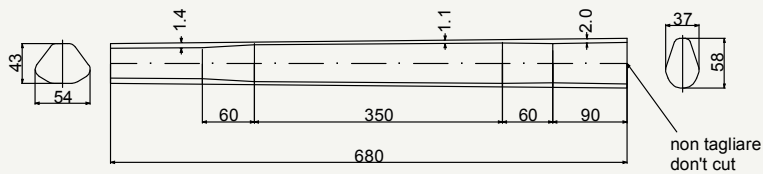

cod : MTQ480E10311

Alloy	Weight	Use
7005	365 g	Road - Cyclocross - MTB

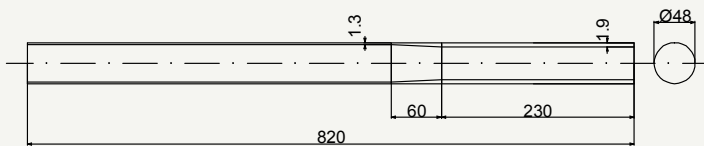

cod : MTQ480E102

Alloy	Weight	Use
7005	480 g	MTB 29"

# Fire seat tubing

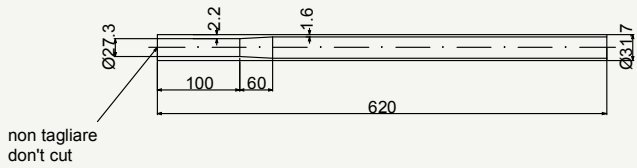

cod : MTV317E10111

Alloy	Weight	Use
7005	290 g	Road - Cyclocross - MTB

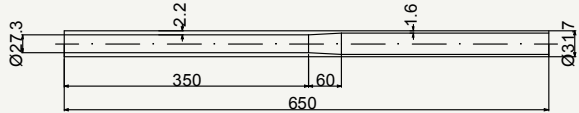

cod : MTV317E2017

Alloy	Weight	Use
7005	328 g	Road Low Geometry

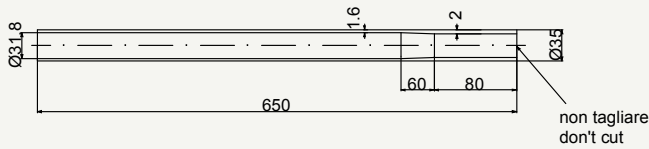

cod : MTV350E307

Alloy	Weight	Use
7005	314 g	Cyclocross - MTB

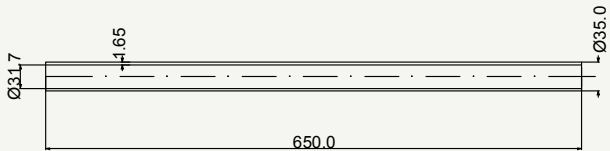

cod : MTV350E313

Alloy	Weight	Use
7005	318 g	Road - Cyclocross - MTB



cod : MTV350E31318

Alloy	Weight	Use
7005	318 g	Track

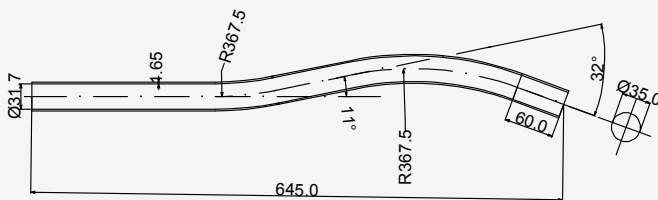

cod : MTV350E3131

Alloy	Weight	Use
7005	318 g	Track

# Fire chain stay

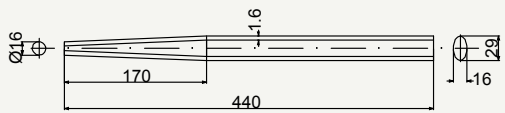

SIDE VIEW

cod : MPO240E101

Alloy	Weight	Use
7005	128 g	Road

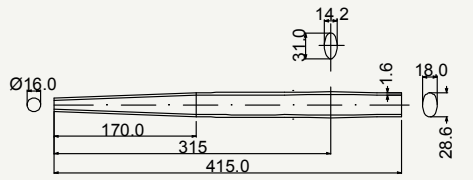

SIDE VIEW

cod : MPO240E104

Alloy	Weight	Use
7005	120 g	Road - Track

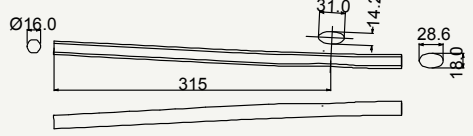

TOP VIEW

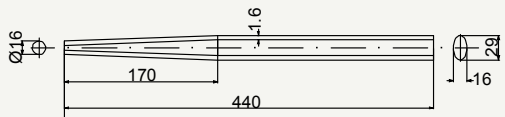

SIDE VIEW

cod : MPO240E10146

Alloy	Weight	Use
7005	128 g	Road

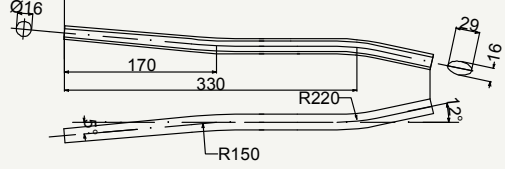

TOP VIEW

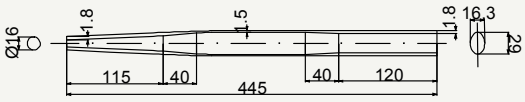

SIDE VIEW

cod : MPO240E1015

Alloy	Weight	Use
7005	143 g	Fat Bike

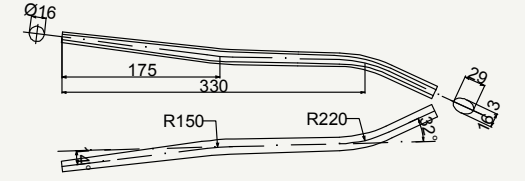

TOP VIEW

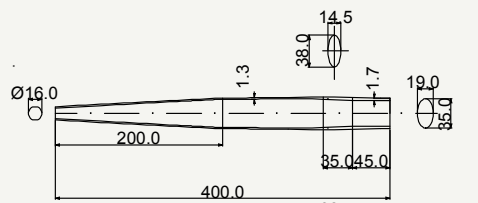

SIDE VIEW

cod : MPO280E106

Alloy	Weight	Use
7005	120 g	Road - Track

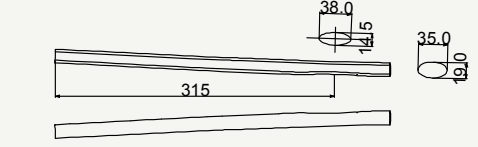

TOP VIEW



# Fire seat stay

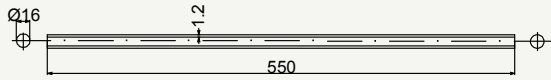

cod : MPV160E101

Alloy	Weight	Use
7005	87 g	Road

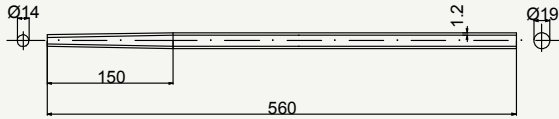

cod : MPV190E10112

Alloy	Weight	Use
7005	98 g	Road

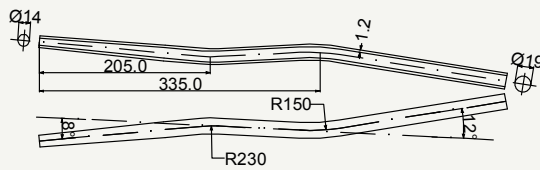

TOP VIEW

cod : MPV190E10123

Alloy	Weight	Use
7005	98 g	Cyclocross

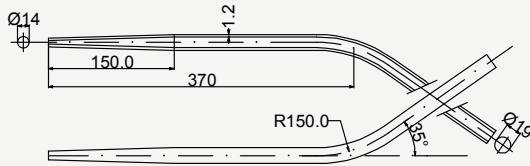

TOP VIEW

cod : MPV190E10121

Alloy	Weight	Use
7005	98 g	Fat Bike

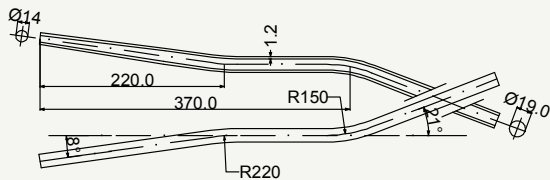

TOP VIEW

cod : MPV190E10133

Alloy	Weight	Use
7005	98 g	Gravel - MTB 29"



cod : MPV220F101

Alloy	Weight	Use
7005	97 g	Road



SIDE VIEW

cod : MPV220F1011

Alloy	Weight	Use
7005	97 g	Crono - Track

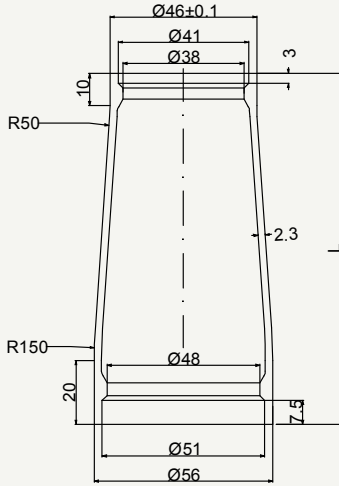

cod : MTS56E085

Alloy	Lenght	Weight	Use
7020	86	122 g	Road

cod : MTS56E096

Alloy	Lenght	Weight	Use
7020	97	138 g	Road

cod : MTS56E110

Alloy	Lenght	Weight	Use
7020	111	156 g	Road

cod : MTS56E120

Alloy	Lenght	Weight	Use
7020	121	162 g	Road

cod : MTS56E135

Alloy	Lenght	Weight	Use
7020	136	178 g	Road

cod : MTS56E155

Alloy	Lenght	Weight	Use
7020	156	202 g	Road

cod : MTS56E180

Alloy	Lenght	Weight	Use
7020	181	218 g	Road

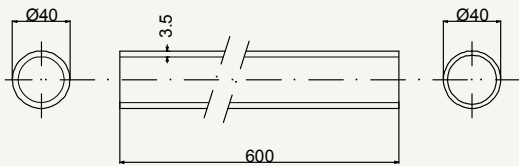

cod : MTS41040200E

Alloy	Lenght	Weight	Use
7005	600	674 g	Road - MTB

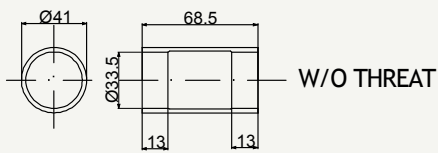

cod : MBS4468BS

Alloy	Weight	Use
7005	76 g	Road - Cyclocross - MTB

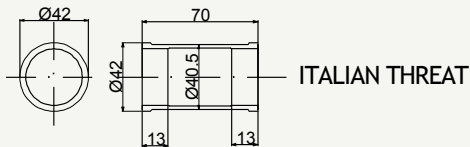

cod : MBSITAD79

Alloy	Weight	Use
7005	47 g	Road

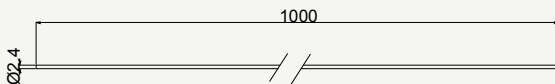

cod : MWR2401000SC

Alloy	Weight	Use
SC	12 g	ALLS



## Chemical composition of Scandium alloy%

	Min / Max
Si	0.20/0.50
Fe	0.03/0.08
Cu	0.25/0.35
Mn	0.25/0.35
Mg	2.20/1.80
Cr	<0.005
Zn	4.50/5.50
Ti	0.025/0.035
Pb	<0.002
Zr	0.10/0.15
Na	<0.0001
Sc	0.10/0.15

## Typical Mechanical proprieties of Scandium alloy tubing T6 state:

- Ultimate strength > 550 Mpa (Best value 580 Mpa)
- Yield strength > 490 Mpa
- Elongation % > 8 %

Structural analysis data:

- Density 2.80 g/cm<sup>3</sup>
- Modulus of Elasticity 71.5 GPa
- Yield strength > 450 MPa





## Chemical composition of EN-AW 7020 alloy%

	Min/Max
Si	< 0.35
Fe	< 0.40
Cu	< 0.20
Mn	1.00/1.40
Mg	0.05/0.50
Cr	0.10/0.35
Zn	4.00/5.00
Ti	< 0.05
Pb	< 0.05
Zr	0.08/0.20
Bi	< 0.05
Sn	< 0.05
V	< 0.05
Others	< 0.05

## Typical Mechanical proprieties of EN-AW 7020 alloy tubing T6 state:

- Ultimate strength > 390 Mpa
- Yield strength > 350 Mpa
- Elongation% > 10 %

Structural analysis data :

- Density 2.80 g/cm<sup>3</sup>
- Modulus of Elasticity 71.5 GPa
- Yield strength > 330 MPa







## Chemical composition of 7005 alloy%

	Mix/Max
Si	< 0.35
Fe	< 0.40
Cu	< 0.10
Mn	0.20/0.70
Mg	1.00/1.80
Cr	0.06/0.20
Zn	4.00/5.00
Ti	0.01/0.06
Pb	< 0.05
Zr	0.08/0.20
Bi	< 0.05
Sn	< 0.05
Ni	< 0.05
Others total	< 0.15

## Typical Mechanical proprieties of 7005 alloy tubing T6 state:

- Ultimate strength > 380 Mpa
- Yield strength > 340 Mpa
- Elongation% > 10 %

Structural analysis data :

- Density 2.80 g/cm<sup>3</sup>
- Modulus of Elasticity 71.5 GPa
- Yield strength > 320 MPa



## Assembling of the tubing

### Geometrical features

All the Dedacciai tubes and tube sets are designed for assembling frames based on current UCI geometry.

In the choice of tubing for manufacturing a frames, please keep into account the following safety rules:

- Verify that for the selected geometry you will save a butt length longer than the thermal affected zone, and in any case longer than the tube diameter.
- If the butt length of down and top tubing butts are not symmetrical, pay attention in the tube orientation : at the head tube joint the tube must be only mitred, and not cutted.
- Depending on geometry, it is always better to keep top and down tubing spaced on head tube. Over imposed tubing geometries are less safe.
- Road recommended tubing can't be used for off-road frames.
- Fixing point and welding cordons closure points can give origin to fatigue cracks, realize them in the less stressed areas of the joints.
- It is recommended to completely weld the seat tube on bottom bracket, and then all other tubing.
- Top tube and seat stays must be approximately aligned at the seat tube joint. If you want to weld the seat stays below the top tube center line, please use the "low geometry (LG)" seat tubing.
- Do not grind and/or polish the welding cordons. The risk of reducing the tube wall thickness is too high!







## Welding and post-welding advices

- After cutting and before welding the tubing, brush the ends of them with care, using Inox brush or 3M Scotch Brite, in order to remove oxides and deburr the milled edges. The edges must be smooth and without notches. After mechanical action, use alcohol to degrease and clean the welding surfaces.
- All the Dedacciai aluminum alloy tubing are compatible, and can be welded together.

Suggested welding wires are:

for 7005 and 7020 tubing -> 5356 or 5183

for Scandium tubing -> Dedacciai Sc wire MWR2401000SC

Dedacciai Sc wire is supplied free of any charge with scandium tubing, or can be bought as spare part.

- Dedacciai recommend to use components in 7020 or 7005 alloy for structural reasons in the frame fabrication.  
If it is necessarily to use other alloys, suggested welding wires are:

For 5000 alloy series components: S-Al Mg 4,5 Mn (5183)

For 6000 alloy series components: S-Al Si 5 (4043) or S-Al Mg 5 (5356)

- After welding, artificial aging of the frame is strongly recommended within 7 days from the manufacturing date.  
This heat treatment acts as hardening process for the thermal affected zones, and as stress relief treatment for the whole structure.  
It is very important to assure long term reliability of the frame.

The suggested parameters are:

120 °C +/- 5°C for 12 – 16 hours

- 7000 alloys are sensitive to corrosion and tensile-corrosion phenomenon. Anticorrosion treatment is needed on the finished frame, before painting stage
- 7000 alloys frame are sensitive to high temperatures, please make sure that during the painting stage frames do not exceed 165 °C.



Dedacciai Srl - Via Leonardo da Vinci, 19 - 26010 Campagnola Cremasca (CR) - Italy - Ph. +39 0373 74 499 - [www.dedacciai.com](http://www.dedacciai.com)

